



imes-icore[®]
Dental & Medical Solutions



CORiTEC[®] 350i series

The CORiTEC® 350i series

WHAT ARE THE DIFFERENCES?

	CORiTEC 350i PRO		CORiTEC 350i Loader PRO*	
Motor technology	Servo with absolute encoder			
Resolution	32.000 Inc (0.15 µm)			
Base structure	Polymer concrete, steel rails			
Screen	15" HD touchscreen			
Housing	Shiny design, LED illumination			
Fully automatic workpiece blankchanger	Manual	 12-fold	Manual	 12-fold
Blankholder inclusive	2	8	2	8
Absolute measurement systems in all axes	✓	✓	✓	✓
Spindle power	1.0 kW	1.0 kW	2.6 kW	2.6 kW
Spindle bearing	Two hybrid bearings		Three hybrid bearings	
Collet	6 mm		6 mm (self cleaning)	
Zero point clamping system	✓	✓	✓	✓
Cooling system spindle	Air cooled		Water cooling system	



THE BUSINESS CLASS
of dental
CAD/CAM machines!



CORiTEC® 350i PRO/350i Loader PRO

THE PROFESSIONAL SOLUTION FOR HIGHEST DEMANDS

The high-resolution dynamic servo motors with absolute measuring systems used in the CORiTEC 350i PRO series guarantee up to 20 % faster machining with optimum precision.

A further advantage of the PRO series is that this machine system is constructed from a one-piece machine frame made of polymer concrete and thus guarantees the highest possible stability for vibration-free machining.

The CORiTEC 350i Loader PRO with fully automated blank magazine also enables versatile machining of up to 12 blanks in unmanned operation. Due to the precise repositioning of the zero point clamping system, different PreFab abutment holders can be used.



- WET
- DRY
- 5 AX
- 6 mm
20x
- Temperature icon
- Touchscreen icon
- Mobile device icon
- Blank magazine icon
- 12x
- ION
optional

CORiTEC[®] 350i PRO

ALL CAD/CAM MATERIALS
CAN BE PROCESSED

15 INCH
TOUCHSCREEN

REVOLUTIONARY
BASE STRUCTURE OF
POLYMER CONCRETE

INTEGRATED TEMPERATURE
COMPENSATION



INTEGRATED
WET AND DRY
PROCESSING

ABSOLUTE MEASURING
SYSTEM IN ALL AXES

ZERO-POINT
CLAMPING
SYSTEM
STANDARD

20-FOLD
TOOL CHANGER

PMMA	WAX
Zr	COMPOSITE
PEEK	SINT
Glass ceramics	PreFab Abutments
CoCr	Ti
Standard	C-Clamp
PreMilled Abutment	Block
Dentures	Zero point clamping system
Crowns, Bridges	Hybrid Abutment
Inlay, Onlay, Veneer	Splint
Full Denture	Surgical guide
Model	Model casting
Bridge	Abutments
Telescopic technology	Hybrid machining

CORiTEC[®] 350i Loader PRO

FULLY AUTOMATIC
12-FOLD BLANK CHANGER

USE OF DIFFERENT ADAPTER SYSTEMS
e.g. prefabricated abutments or block materials

NEW, HIGH-DYNAMIC SERVO DRIVES
for up to 20 % quicker processing

INTEGRATED
WET AND DRY
PROCESSING

AROUND THE CLOCK
24 hours of production

ZERO POINT
CLAMPING
SYSTEM

IONIZER
OPTIONAL

INTEGRATED
TEMPERATURE
COMPENSATION



CORiTEC® 350i PRO⁺/350i Loader PRO⁺

THE PLUS OF PERFORMANCE AND PRECISION

As already implemented in the CORiTEC 350i PRO, the CORiTEC 350i PRO⁺ series also comes with high-resolution dynamic servo motors and absolute measuring systems. To use this advanced technology and to be able to fully exploit its full potential, the CORiTEC 350i PRO⁺ is equipped with a water-cooled, powerful 2.6 kW spindle with 3-fold hybrid ball bearing. Reaching the stability and reducing vibrations is given by the massive stainless steel blank holders.

The water cooling ensures a constant temperature of the milling spindle, so thermal expansion of the milling spindle is significantly minimized and enables even more precise milling results.

The CORiTEC 350i Loader PRO⁺ with fully automated blank magazine also enables the versatile machining of up to 12 blanks in unmanned operation.

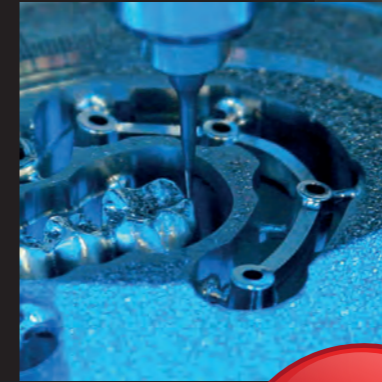

Zero-point clamping system for stainless steel blank holder

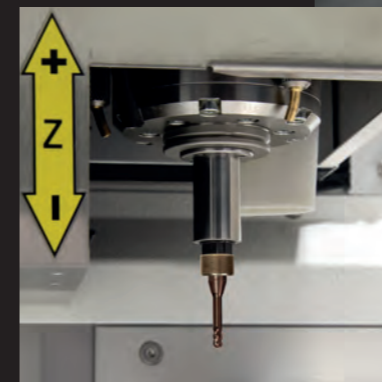

- WET
- DRY
- 5 AX
- 6 mm
20x
-
-
-
-
- 12x
- ION
optional

CORiTEC® 350i PRO⁺

HIGH-RESOLUTION DYNAMIC
SERVO MOTORS
with absolute measuring system

INTEGRATED WET
AND DRY PROCESSING

2,6 KW SPINDEL
water cooled, powerful

20-FOLD
TOOL CHANGER

IONIZER
OPTIONAL



STAINLESS STEEL BLANK HOLDER

INTEGRATED
TEMPERATURE
COMPENSATION

PMMA	WAX
Zr	COMPOSITE
PEEK	PreFab Abutments
Glass ceramics	Ti
CoCr	
Standard	C-Clamp
PreMilled Abutment	Block
Dentures	Zero point clamping system
Crowns, Bridges	Hybrid Abutment
Inlay, Onlay, Veneer	Splint
Full Denture	Surgical guide
Model	Model casting
Bridge	Abutments
Telescopic technology	Hybrid machining

CORiTEC® 350i Loader PRO⁺

STAINLESS STEEL
BLANK HOLDER

IONIZER
OPTIONAL



NEW, HIGH-DYNAMIC SERVO DRIVES
for up to 20 % quicker processing

INTEGRATED WET
AND DRY PROCESSING

2,6 KW SPINDEL
water cooled, powerful

AROUND THE CLOCK
24 hours of production

INTEGRATED
TEMPERATURE
COMPENSATION

CORiTEC® Aligner STARTERKIT

THE UPGRADE FOR YOUR EXISTING MACHINE!

Do you already have a CORiTEC 350i PRO or PRO+ series milling system? Simply expand it with the CORiTEC **Aligner** Starter Kit. Thanks to its holder system with integrated zero-point clamping system, you can start your aligner production in just a few steps.

- 1x tool case
- 1x holder set with integrated zero point clamping system
- 5x base plate to hold the blanks
- 5x special milling tool



CORiTEC® 350i PRO/PRO+ series

+



CORiTEC® Starter Kit

=



Mixed operation
of dental and
aligner applications

Expand the functionality of your 350i machine...

...AND STAY FLEXIBLE!



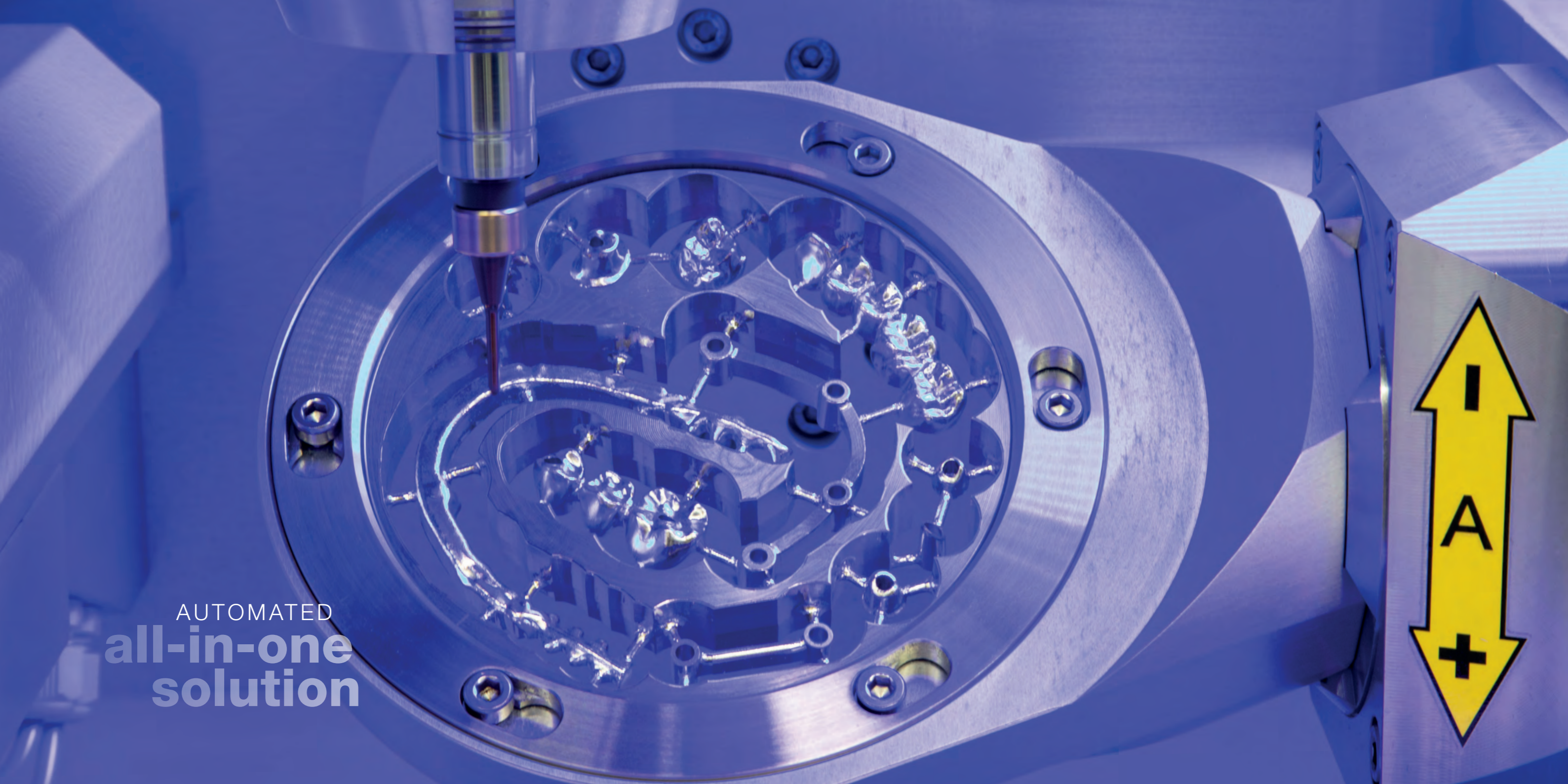

AUTOMATED
**all-in-one
solution**

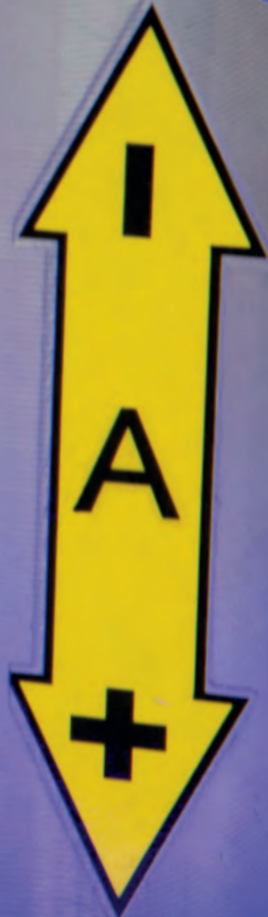

Applications & holder

HALF-OPEN BLANK HOLDER (C-CLAMP)

- Enables 5-axis machining up to 90 degrees axis adjustment
- Extends the technical possibilities of your milling machine
- End face machining



MANUFACTURE OF DENTAL PROSTHESES

- Baltic Denture from Merz Dental
- Dentsply Sirona Dentures



PREFABRICATED ABUTMENTS

- Short production times
- Production of abutments in very simple processes
- High accuracy of fit due to prefabricated implant interface

NT-Preform® Abutment (nt-trading)



PreFace® Abutment (Medentika)

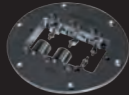

MED-Preform® Abutment (medentis)



DESS Abutmentholder



ELOS premilled Abutment System



THERAPEUTIC SPLINTS

- Bite splints, bleaching splints
- Snoring splints, aligners
- Simple and high-quality implementation in CAD/CAM processes



UNIVERSAL HOLDER FOR TURN-MILL-GRINDING PROCESSING

- High precision
- Improved surface quality
- Tool-saving machining
- Suitable adapters:

Universal



NT-Trading



Medentika



Dental Direkt



HYBRID MACHINING - SINTERING AND MILLING

- Milling post-processing of finished restorations using the SLM method
- High precision milling combined with low-cost SLM process
- Compatible with most SLM systems



GRINDING OF CAD/CAM BLOCKS

- New 6-fold adapter enables effective production
- Exchangeable strips for different adapter systems
- Crowns, onlays, inlays, veneers, bridge frameworks etc.

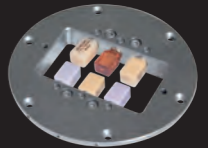

IMPLANT-SUPPORTED BRIDGES AND BARS / ONE-PIECE ABUTMENTS

- Highest fitting accuracy due to new CAM technologies (ReFit)
- Stress-free fit even with larger spans
- Easy production due to high degree of automation with coordinated CAM software



BIOHPP ELEGANCE PREFABS

- Individual hybrid abutment on PEEK basis
- BioHPP for permanent dentures, free of metal, oxide and monomer
- Homogeneous combination of titanium and BioHPP



MILLING OF MODEL CASTS

- Production in burnout materials, PEEK or directly in CoCr
- Allergy-free and lightweight model casting when using PEEK
- Cost-efficient

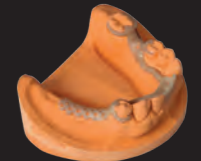

MILLED IMPLANT MODELS

- DIM (Digital Implant Model) from nt-trading
- Precisely positionable
- 2-part implant analog



Cutters & grinders | 6 mm shaft

CUSTOMIZED SOLUTIONS OPTIMIZED FOR THE PARTICULAR MATERIALS AND EQUIPMENT

T1/T6 - 3.0 | 6.0 mm
radius milling tool short (l = 15 mm)

T1	Ti
T6	CoCr

3.0 mm Ø 6 mm

up to 15 mm

Blades

Art.-No. 526029 3006

T5/T10 - 1.5 | 6.0 mm
shaft milling tool short (l = 12 mm, four blades)

T5	Ti
T10	CoCr

1.5 mm Ø 6 mm

up to 15 mm

Blades

Art.-No. 526002 1506

T12/T14 - 1.0 | 6.0 mm
radius milling tool

T12	PMMA
	WAX
T14	Zr

1.0 mm Ø 6 mm

up to 25 mm

Blades

Art.-No. 526019 1006

T17 - 1.5 | 6.0 mm
shaft milling tool (l = 15 mm)

	PMMA
T17	WAX
	Zr

1.5 mm Ø 6 mm

up to 25 mm

Blades

Art.-No. 526001 1506

T2/T7 - 2.0 | 6.0 mm
radius milling tool short (l = 12 mm)

T2	Ti
T7	CoCr

2.0 mm Ø 6 mm

up to 15 mm

Blades

Art.-No. 526029 2006

T11 - 2.5 | 6.0 mm
radius milling tool (single blade, slide coated)

	PMMA
T11	WAX
	PEEK

2.5 mm Ø 6 mm

up to 25 mm

Blade

Art.-No. 530004 2506

T13/T40/T50 - 2.5 | 6.0 mm
radius milling tool (diamond coated)

T13	Zr
T40	SINT
T50	COMP

2.5 mm Ø 6 mm

up to 25 mm

Blades

Art.-No. 526013 2506

T18 - 0.5 | 6.0 mm
radius milling tool (l = 4 mm)

T18	UNIVERSAL*
-----	------------

0.5 mm Ø 6 mm

up to 15 mm

Blades

Art.-No. 526026 0506

T3/T8 - 1.5 | 6.0 mm
radius milling tool short (l = 12 mm)

T3	Ti
T8	CoCr

1.5 mm Ø 6 mm

up to 15 mm

Blades

Art.-No. 526029 1506

T11/T13 - 2.5 | 6.0 mm
radius milling tool

T11	PMMA
	WAX
T13	Zr

2.5 mm Ø 6 mm

up to 25 mm

Blades

Art.-No. 526019 2506

T14/T41/T51 - 1.0 | 6.0 mm
radius milling tool (diamond coated)

T14	Zr
T41	SINT
T51	COMP

1.0 mm Ø 6 mm

up to 25 mm

Blades

Art.-No. 526013 1006

T19 - 0.5 | 6.0 mm
shaft milling tool (l = 4 mm)

T19	UNIVERSAL*
-----	------------

0.5 mm Ø 6 mm

up to 15 mm

Blades

Art.-No. 526001 0506

T4/T9 - 1.0 | 6.0 mm
radius milling tool short (l = 9 mm)

T4	Ti
T9	CoCr

1.0 mm Ø 6 mm

up to 15 mm

Blades

Art.-No. 526029 1006

T12 - 1.0 | 6.0 mm
radius milling tool (single blade, slide coated)

	PMMA
T12	WAX
	PEEK

1.0 mm Ø 6 mm

up to 25 mm

Blade

Art.-No. 530004 1006

T15/T42/T52 - 0.6 | 6.0 mm
radius milling tool (conical)

	PMMA
T15	WAX
	Zr
T42	SINT
T52	COMP

0.6 mm Ø 6 mm

up to 25 mm

Blades

Art.-No. 526019 0606

T20 - 0.6 | 6.0 mm
radius milling tool (conical)

T20	Ti
	CoCr

0.6 mm Ø 6 mm

up to 15 mm

Blades

Art.-No. 526003 0606

Cutters & grinders | 6 mm shaft

CUSTOMIZED SOLUTIONS OPTIMIZED FOR THE PARTICULAR MATERIALS AND EQUIPMENT

T22 - 1.0 | 6.0 mm
radius grinding tool (diamond)

glass ceramics

1.0 mm Ø 6 mm

Art.-No. 526005 1006

T27 - 2.0 | 6.0 mm
radius milling tool long (l = 16 mm)

Ti
CoCr

2.0 mm Ø 6 mm

16 - 20 mm
Blades

Art.-No. 526030 2006

T32 - 0.6 | 6.0 mm
radius milling tool long (l = 12 mm)

PMMA
WAX
Zr

0.6 mm Ø 6 mm

up to 25 mm
Blades

Art.-No. 526012 0606

T37 - 2.0 | 6.0 mm
radius milling tool long (l = 20 mm)

PMMA
WAX
Zr

1.5 mm Ø 6 mm

up to 30 mm
Blades

Art.-No. 530035 1503

T23 - 0.6 | 6.0 mm
radius grinding tool (conical, diamond)

glass ceramics

0.6 mm Ø 6 mm

Art.-No. 526005 0606

T28 - 1.5 | 6.0 mm
radius milling tool long (l = 15 mm)

Ti
CoCr

1.5 mm Ø 6 mm

16 - 20 mm
Blades

Art.-No. 526030 1506

T34 - 3.0 | 6.0 mm
radius milling tool long (l = 27 mm)

PMMA
WAX

3.0 mm Ø 6 mm

up to 30 mm
Blades

Art.-No. 526012 3006

T61 - 3.0 | 6.0 mm
Quattro speed milling tool (l = 15 mm)

CoCr

3.0 mm Ø 6 mm

up to 15 mm
Blades

Art.-No. 526025 3006

T24 - 1.5 | 6.0 mm
radius grinding tool (diamond)

glass ceramics

1.5 mm Ø 6 mm

Art.-No. 526005 1506

T29 - 1.0 | 6.0 mm
radius milling tool long (l = 11 mm)

Ti
CoCr

1.0 mm Ø 6 mm

16 - 20 mm
Blades

Art.-No. 526030 1006

T35 - 2.0 | 6.0 mm
radius milling tool long (l = 20 mm)

PMMA
WAX

2.0 mm Ø 6 mm

up to 30 mm
Blades

Art.-No. 526012 2006

T62 - 2.0 | 6.0 mm
torus milling tool (r = 0,2 mm, l = 16 mm, four blades)

Ti
CoCr

2.0 mm Ø 6 mm

up to 15 mm
Blades

Art.-No. 526025 2006

T26 - 3.0 | 6.0 mm
radius milling tool long (l = 20 mm)

Ti
CoCr

3.0 mm Ø 6 mm

16 - 20 mm
Blades

Art.-No. 526030 3006

T30 - 4.0 | 6.0 mm
shaft milling tool long (l = 32 mm, single blade, slide coated)

PMMA
WAX
PEEK

4.0 mm Ø 6 mm

up to 30 mm
Blade

Art.-No. 526012 4006

T36 - 4.0 | 6.0 mm
radius milling tool long (l = 31 mm)

PMMA
WAX

4.0 mm Ø 6 mm

up to 30 mm
Blades

Art.-No. 530019 4006

T63 - 1.5 | 6.0 mm
torus milling tool (r = 0,08 mm, l = 7 mm, two blades)

Ti
CoCr

1.5 mm Ø 6 mm

up to 15 mm
Blades

Art.-No. 526025 1506

Cutters & grinders | 6 mm shaft

CUSTOMIZED SOLUTIONS OPTIMIZED FOR THE PARTICULAR MATERIALS AND EQUIPMENT

T64 - 1.5 | 6.0 mm
torus milling tool (r = 0,08 mm, l = 15 mm, two blades)



Art.-No. 526028 1506

T80 - 2.5 | 6.0 mm
drilling tool (l = 22 mm)

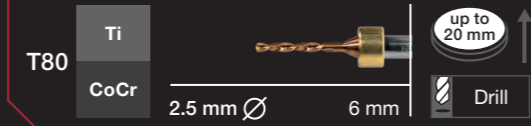

Art.-No. 526023 2506

T98 - 2.5 | 6.0 mm
shaft milling tool (l = 20 mm, three blades)

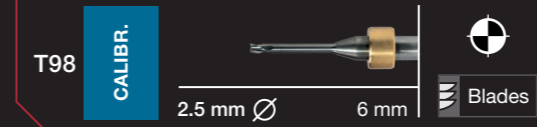

Art.-No. 526024 2506

T124 - Ø 2.0 x 1.0 | 6.0 mm
T-tool 90° (d = 1.0 mm, l = 9.5 mm, three blades)

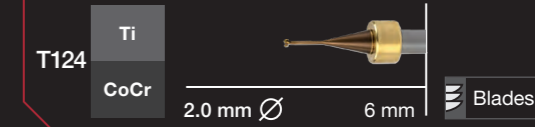

Art.-No. 530040 2006

T103 - M2 | 6.0 mm
Thread milling tool



Art.-No. 526040 2006

T112 - 1.5 | 6.0 mm
shaft milling tool (single blade)



Art.-No. 526041 1506

T67 - 2.0 | 6.0 mm
shaft milling tool short (l = 7 mm, four blades)



Art.-No. 526002 2006

T81 - 1.5 | 6.0 mm
drilling tool (l = 18 mm)

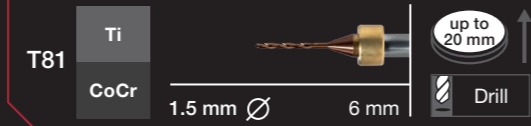

Art.-No. 526023 1506

T121 - Ø 1.6 x 0.7 | 6.0 mm
T-tool 90° (d = 0.65 mm, l = 7.5 mm, three blades)



Art.-No. 530040 1606

T68 - 1.5 | 6.0 mm
shaft milling tool long (l = 15 mm, four blades)

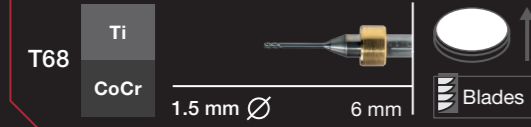

Art.-No. 526021 1506

T82 - 2.65 | 6.0 mm
drilling tool (l = 21 mm)



Art.-No. 526031 26506

T122 - Ø 1.7 x 0.7 | 6.0 mm
T-tool 90° (d = 0.65 mm, l = 8.0 mm, three blades)



Art.-No. 530040 1706

T69 - 1.5 | 6.0 mm
shaft milling tool (l = 7 mm, four blades)



Art.-No. 530032 1506

T83 - 2.25 | 6.0 mm
drilling tool (l = 21 mm)



Art.-No. 526032 22506

T123 - Ø 1.8 x 1.0 | 6.0 mm
T-tool 90° (d = 0.9 mm, l = 7.1 mm, three blades)



Art.-No. 530040 1806



Materials

priti® MULTIDISC (ZIRCONIUM DIOXIDE)

High-end zirconium dioxide for the highest mechanical and aesthetic demands. Indications for use include up to 16-unit bridges, limited to a maximum of 3-unit bridges for High Translucent.

A large selection of colors and heights is available.



	Translucency	Strength
Multi Translucent PLUS	49-45 %	800 – 1150 MPa
Multi Translucent	49-40 %	800 – 1150 MPa
High Translucent	49 %	> 650 MPa
Extra Translucent	45 %	> 1150 MPa
Translucent	40 %	> 1150 MPa
Opaque	35 %	> 1150 MPa

CORTEC SPLINT COMFORT POLYMERS

Extremely comfortable and biocompatible material for the manufacturing of therapeutic splints such as occlusal or stabilization splints. Becomes more flexible at mouth temperature for maximum wearing comfort.

Available in 16 mm and 20 mm.

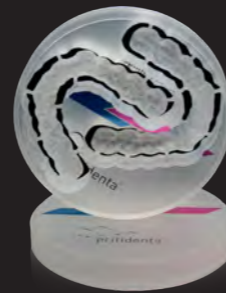

CORTEC SPLINT BASIC POLYMERS

Crystal-clear material for the manufacturing of therapeutic splints and drilling templates.

Available in 16 mm and 20 mm.

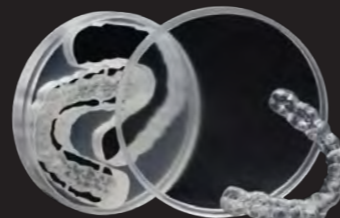

CORTEC TEMP PMMA DISC

An excellently processable material suitable for long-term provisionals with a wear duration of up to three years, including intrinsic color gradients.

Available in 8 Vita colors in 16 mm and 20 mm.

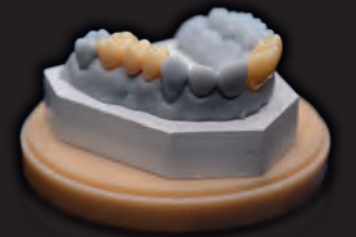

CORTEC GUM PMMA DISC

For gingiva replacement, available in 25 mm.

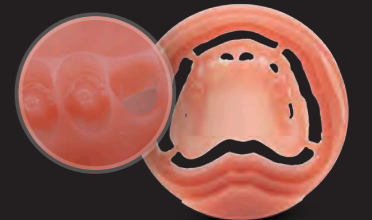

CORTEC TITAN GRADE 5 DISC

CORTEC Titan Grade 5 milling blanks made of titanium alloys are particularly suitable for the production of dental implants, bridge work, and combination work. This material is characterized by excellent millability and very good biocompatibility.

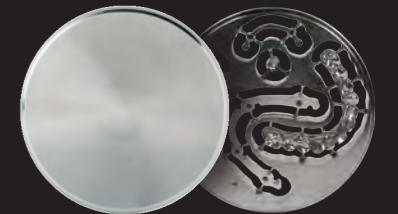

TO priti® MULTIDISC & CORTEC MATERIALS

Scanner COMPATIBLE WITH **exocad**

CORiTEC i3Dscan eco

- All-round carefree package for newcomers or small laboratories
- Simple, fast, low-priced
- Very compact design



CORiTEC i3Dscan color

- Automatic object guidance into the measuring field
- Modern touch-operation design
- The 180-degree opening offers a large working area



CORiTEC i3Dscan color HR

- Enormously high scanning efficiency and precision (4 µm)
- Color Texture scan
- Blue-Light LED & High resolution camera (2.8 MP)
- All modules included in the scope of delivery

CAM Software

CORiTEC iCAM V5 smart

- All strategies optimized for 5-axis simultaneous machining
- Automatic exchange of implant connections (ReFit option)
- No annual license fees
- Fully automatic and easy operation with “Wizard Workflow”

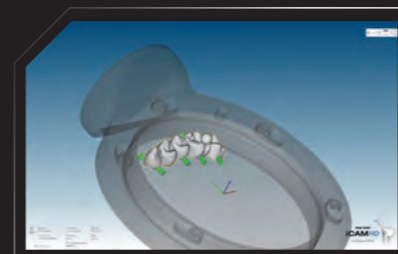

CORiTEC iCAMHD

- hyperDENT based CAM software
- Flexible payment model (purchase or subscription model)

Machine tables

The undercounters, specially developed for the needs of the various machine types, impress with their sturdy design as well as their attractive appearance. The machine tables have sufficient floor space. Stable rollers ensure optimum stability and easy movement of the devices. Drawers, cable ducts and a cabinet for the integration of appropriate extraction systems are already provided.

Machine Table T1	Machine Table T2
30.3 x 36.6 x 31.1 inch 770 x 930 x 790 mm W x H x D	41.7 x 36.6 x 31.1 inch 1060 x 930 x 790 mm W x H x D
CORiTEC 350i PRO CORiTEC 350i PRO+	CORiTEC 350i Loader PRO CORiTEC 350i Loader PRO+

MACHINE TABLE T1



MACHINE TABLE T2



Dust extraction systems

	iVAC eco+	iVAC silent PRO	iVAC PRO+
Volume flow	260m³/h	240m³/h	280m³/h
Output	1200 W	1610 W	1200 W
Filter system	Dust drawer, HEPA filter	Teflon filter cartridge, automatic cleaning feature	Teflon filter cartridge, automatic cleaning feature
Filter volume	25 l	8 l	15 l
W x D x H	7.3 x 18.1 x 29.5 inch 440 x 460 x 750 mm	10.6 x 21.2 x 21.1 inch 270 x 540 x 535 mm	13.7 x 13.7 x 39.3 inch 350 x 350 x 1000 mm
Supply voltage	100-240 V 50/60 Hz	110-230 V 50/60 Hz	100-240 V 50/60 Hz



Sintering furnances

iSINT eco

The iSINT eco offers high-quality technology as well as suitable accessories for high demands at a fair price. Compact and with a small footprint, the iSINT eco sintering oven still has sufficient capacity for a sintering bowl Ø 100 mm for approx. 25 units. The door stop can be mounted right and left.



iSINT PRO

A larger sintering capacity of up to 80 single crowns is offered by the new iSINT PRO. With a heating system with four high-quality molybdenum disilicide (MoSi₂) heating elements, you can choose between conventional long-term sintering or SPEED sintering at a rate of up to 99 °C/min/ 210.20 °F/min. The iSINT PRO is controlled by a simple and convenient program control. The programs are displayed on a 4-line LCD display. A timer function for overnight sintering or the use of pre-drying programs for shaded zirconium restorations offer further options. In addition, three service programs are available for easy maintenance of the sinter furnace.



	iSINT eco	iSINT PRO
Number of heating elements	4	4
Display	7-segment	4-line LCD
Number of program memories	9	30
Heating chamber capacity	1x sintering tray / 100mm diameter	2x sintering tray / 120mm diameter
Max. heating rate	30°K/min	99°K/min
Power in W	1500 W	3200 W
Lift function	No	Yes
Speedsintering	No	Yes
Supply voltage / frequency	220-240 V / 50/60 Hz	220-240 V / 50/60 Hz

Dimensions

CORiTEC® 350i series

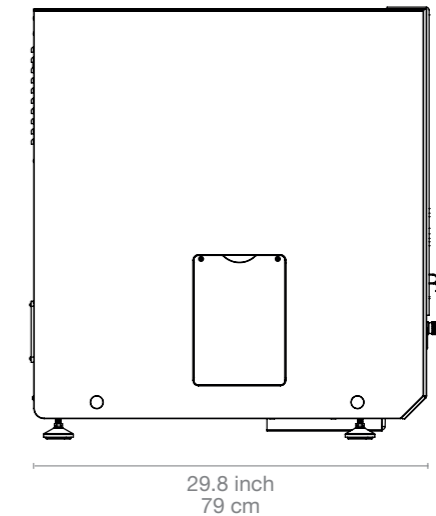
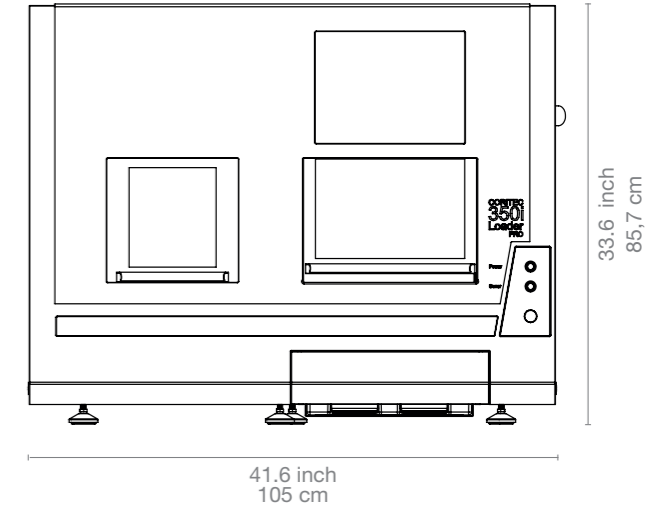
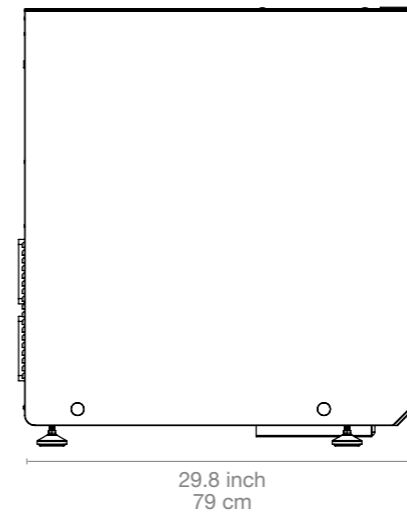
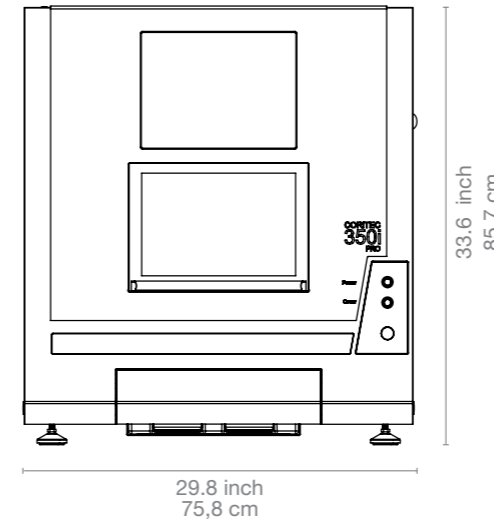

CORiTEC® 350i series in numbers

CORTEC 350i PRO

CORTEC 350i Loader PRO

CORTEC 350i PRO⁺

CORTEC 350i Loader PRO⁺

Mechanics / electronics				
Base structure	Polymer concrete	Polymer concrete	Polymer concrete	Polymer concrete
Number of axes and operation type	5 axes, simultaneous machining	5 axes, simultaneous machining	5 axes, simultaneous machining	5 axes, simultaneous machining
Rotation angle	A-axis 360°, B-axis 115°	A-axis 360°, B-axis 115°	A-axis 360°, B-axis 115°	A-axis 360°, B-axis 115°
Spindle	High-frequency spindle	High-frequency spindle	High-frequency spindle	High-frequency spindle
Maximum spindle speed / spindle power	60.000 rpm 1.0 kW	60.000 rpm 1.0 kW	60.000 rpm 2.6 kW	60.000 rpm 2.6 kW
Spindle cooling	Air cooled	Air cooled	Water cooled	Water cooled
Zero point clamping system	Yes	Yes	Yes	Yes
Blankchanger	-	Up to 12 blanks	-	Up to 12 blanks with stainless steel holder
Tools	Milling and grinding tools with 6 mm shaft	Milling and grinding tools with 6 mm shaft	Milling and grinding tools with 6 mm shaft	Milling and grinding tools with 6 mm shaft
Tool changer	20-times	20-times	20-times	20-times
Tool length control	≤ 0.002 mm precision	≤ 0.002 mm precision	≤ 0.002 mm precision	≤ 0,002 mm precision
Integrated PC	Windows based	Windows based	Windows based	Windows based
Display	Integrated 15" touchscreen	Integrated 15" touchscreen	Integrated 15" touchscreen	Integrated 15" touchscreen
Illumination	3 LED status colors / LED illumination	3 LED status colors / LED illumination	3 LED status colors / LED illumination	3 LED status colors / LED illumination
Software	Remote DENTAL 3.0	Remote DENTAL 3.0	Remote DENTAL 3.0	Remote DENTAL 3.0
Compressed air supply*	6,5 - 9,0bar @ 80l/min 95 - 130PSI @ 2,9cf/min	6,5 - 9,0bar @ 80l/min 95 - 130PSI @ 2,9cf/min	6,5 - 9,0bar @ 80l/min 95 - 130PSI @ 2,9cf/min	6,5 - 9,0bar @ 80l/min 95 - 130PSI @ 2,9cf/min
Cooling liquid	4,8 l 1,27gal (US)	4,8 l 1,27gal (US)	4,8 l 1,27gal (US)	4,8 l 1,27gal (US)
Connecting requirements				
Weight	205 kg / 452.03 lbs	250 kg / 551.25 lbs	210 kg / 463.05 lbs	255 kg / 562.27 lbs
Width x depth x height	29.8 x 31.1 x 33.7 inch 758 x 790 x 857 mm	46.6 x 31.1 x 33.7 inch 1058 x 790 x 857 mm	29.8 x 31.1 x 33.7 inch 758 x 790 x 857 mm	46.6 x 31.1 x 33.7 inch 1058 x 790 x 857 mm
Supply voltage / frequency	100-240 V 50/60 Hz	100-240 V 50/60 Hz	100-230 V 50/60 Hz	100-240 V 50/60 Hz

* acc. to. ISO 8573.1:2010 Class 3.4.3

Rev3.0



Sales and support partner worldwide



Represented for you in over 100 countries.

imes-icore® GmbH has been a leading manufacturer and technology partner since 2003 in the field of dental CAD/CAM systems and solutions.

With its unique range of dental milling and grinding systems imes-icore® offers a perfect selection for all individual requirements of dental laboratories, milling centres and dental practices of all sizes.

Our Open-System product philosophy makes it possible to easily integrate our milling machines into your existing workflow and to integrate them with your open scanners and your CAD/CAM software. We are open for your material selection.

imes-icore® GmbH

Fon +49 (0) 66 72/898 228

Fax +49 (0) 66 72/898 222

dental@imes-icore.com